

**Anbauanleitung:** Seilwindenanbausatz für Seilspulung 1-24441  
IVECO Daily 4x2 ab 2014

**AL:** 2224-01

**Best.Nr.:** 16-9510

**Montagezeit:** ca. 8 Std.

***Hier sehen sie den fertig montierten Seilwindenanbausatz.  
Bevor sie mit der Montage beginnen, lesen sie bitte diese Anleitung und das  
Benutzerhandbuch der Seilwinde gut durch.***

*Before you start fitting, please read and understand this instruction manual and the owners manual of the winch.*



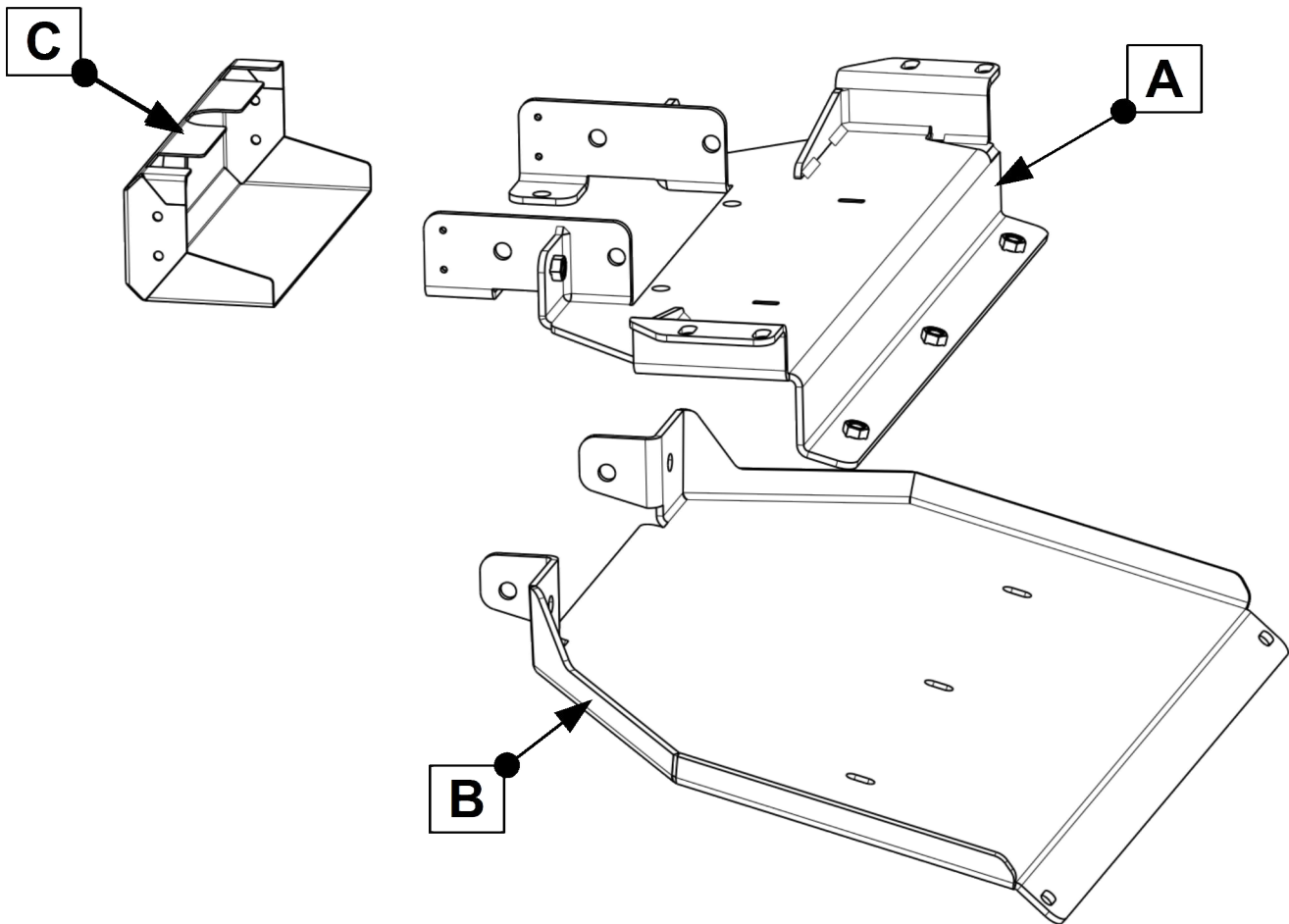

## Stückliste

\*\*\*16-951\*\*\*

## Schraubensatz

1x Aufnahmeträger (A)  
 1x Stützblech (B)  
 1x Abdeckung (C)

1x 1-24441, Seilspulung Zeon / Comeup (D)

1x Anbauanleitung AL2224  
 1x Gutachten  
 1x Aufkleber Kennzeichnung  
 (Bitte an einer sichtbaren Stelle  
 anbringen! TÜV Relevant)

4x Schraube M10 x 30  
 4x Scheibe M10  
 4x Scheibe M10 x 30 x 2  
 4x Federring M10  
 4x Mutter M10

2x Senkkopfschrauben M10 x 40

2x Schraube M8 x 30  
 4x Scheibe M8 x 20 x 1,5  
 2x Federring M8  
 2x Mutter M8

13x Schraube M12 x 40  
 23x Scheibe M12  
 13x Federring M12  
 10x Mutter M12

4x Flanschkopfschraube M6 x 8

**Schrauben Anzugsmomente siehe letzte Seite!**  
*For torque information please see last page!*



2

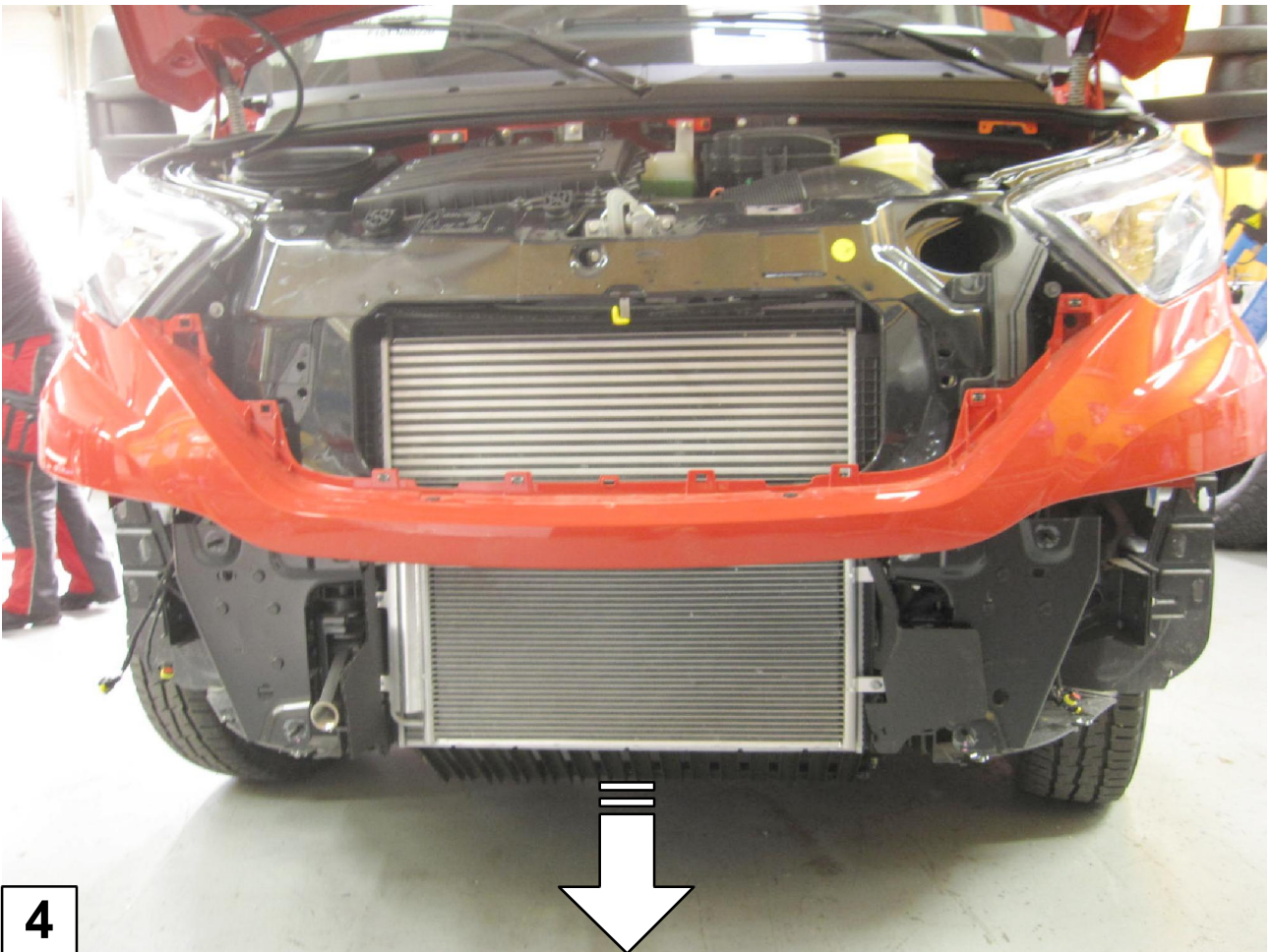

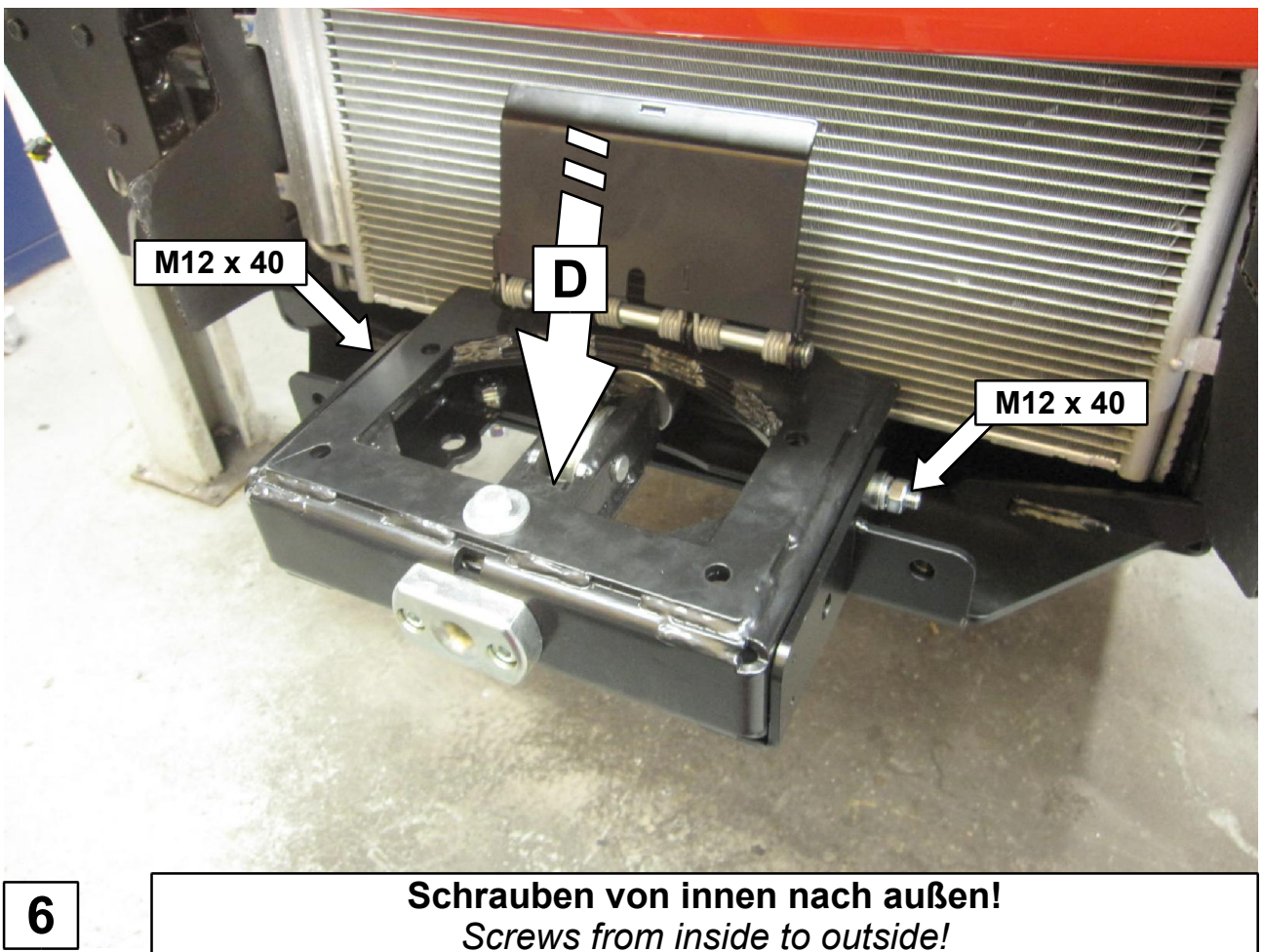
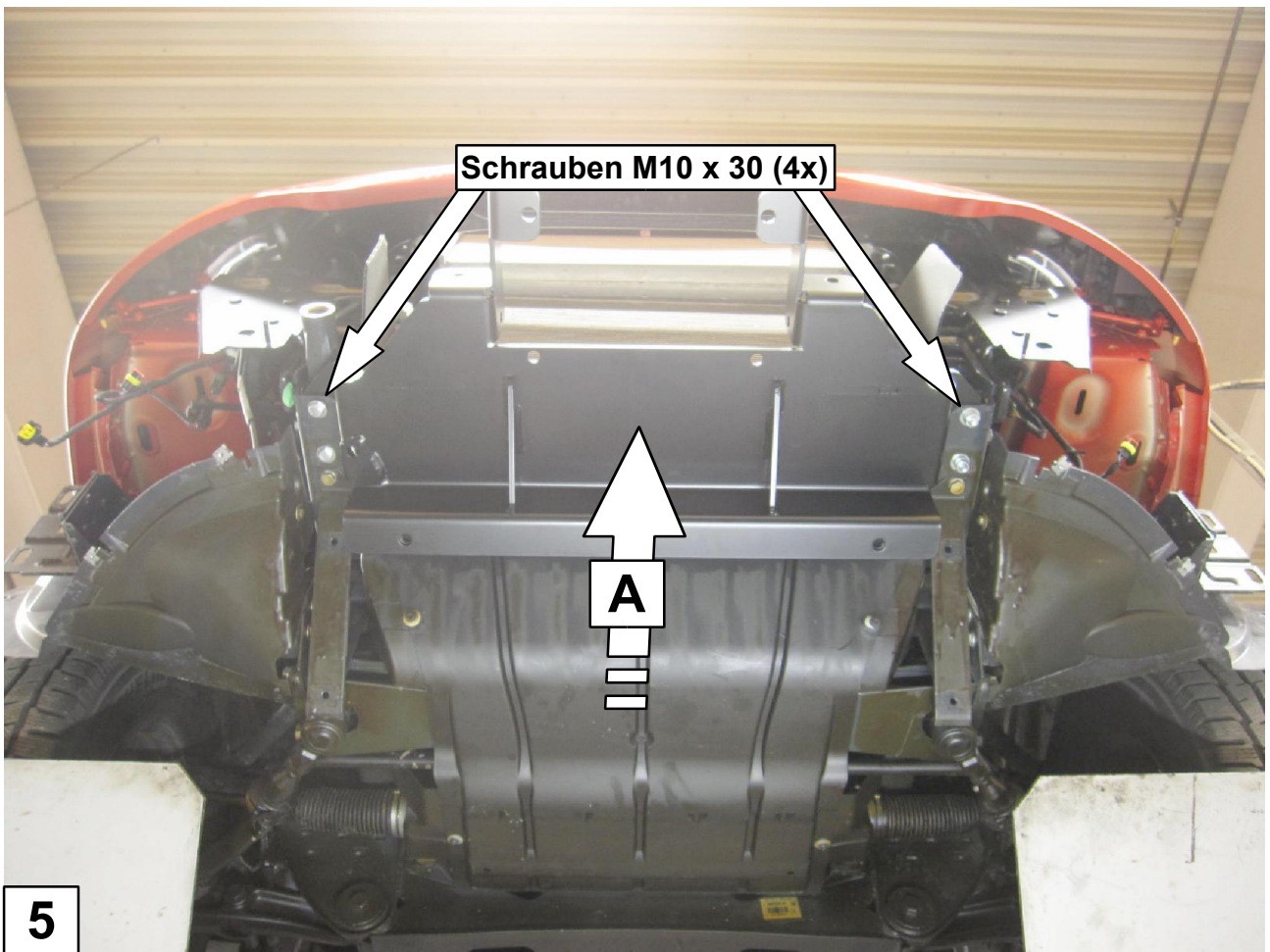

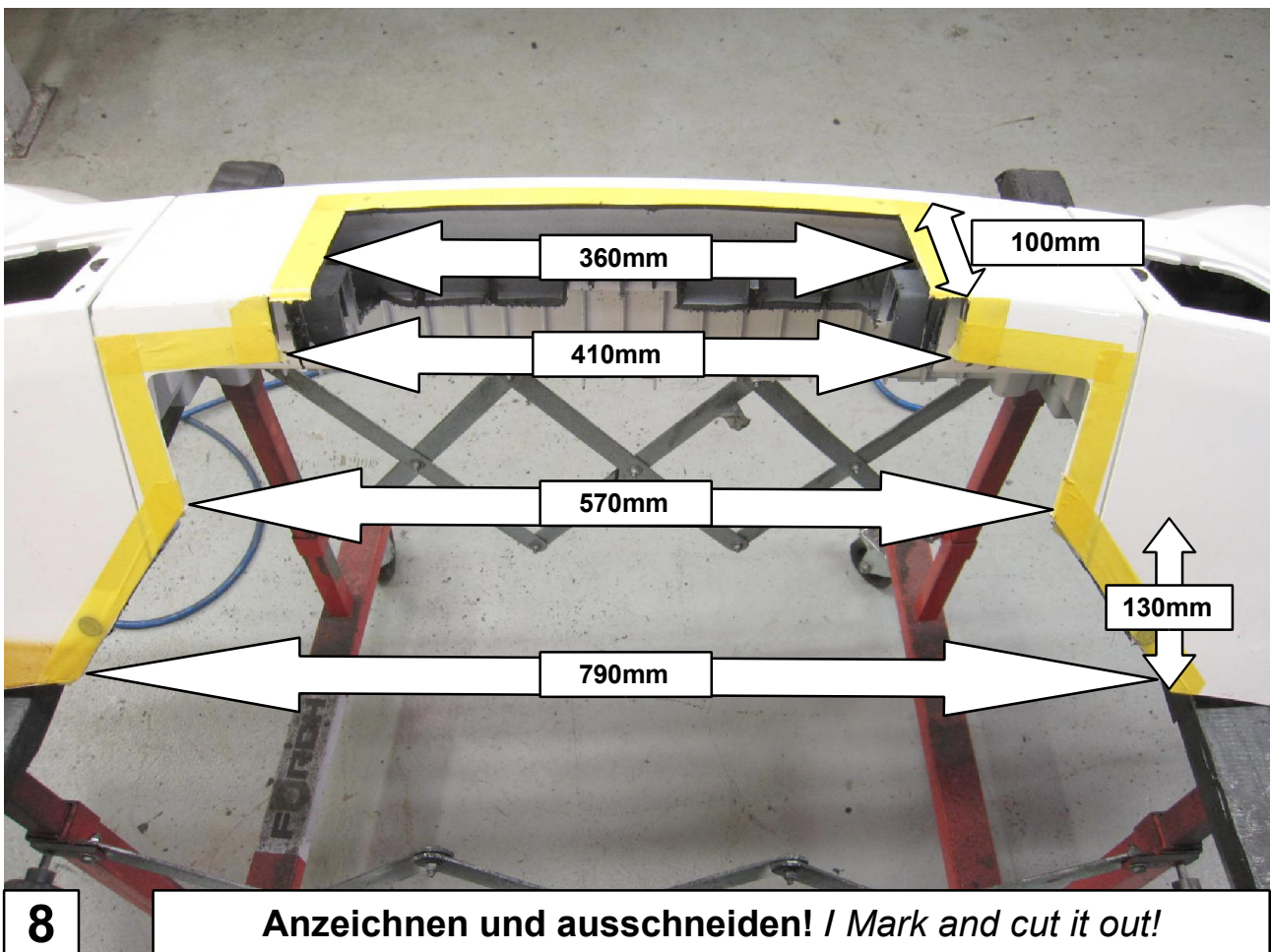
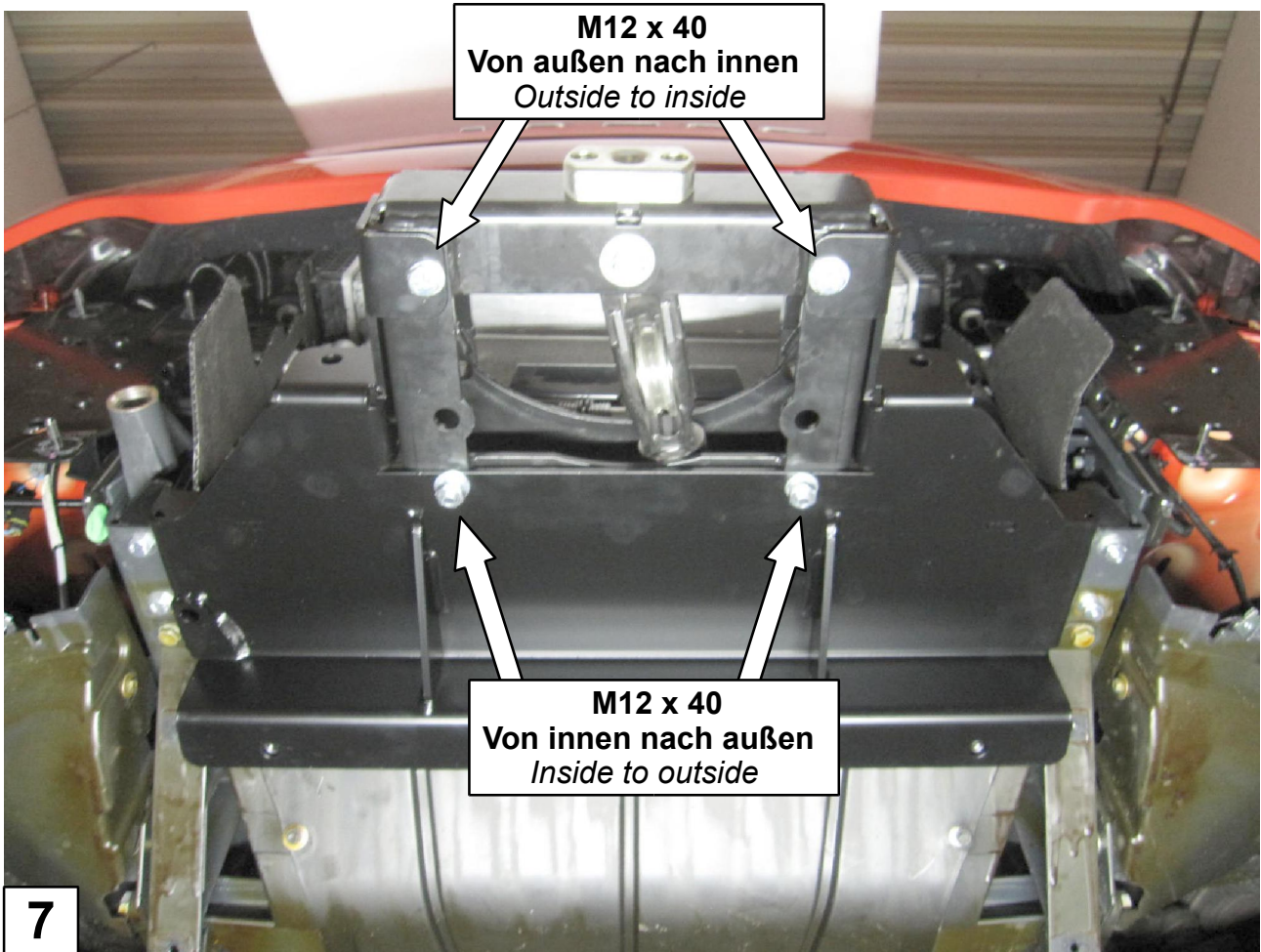



9

**Nach Seilwinde anzeichnen und ausschneiden!**  
*Mark according to winch and cut out!*

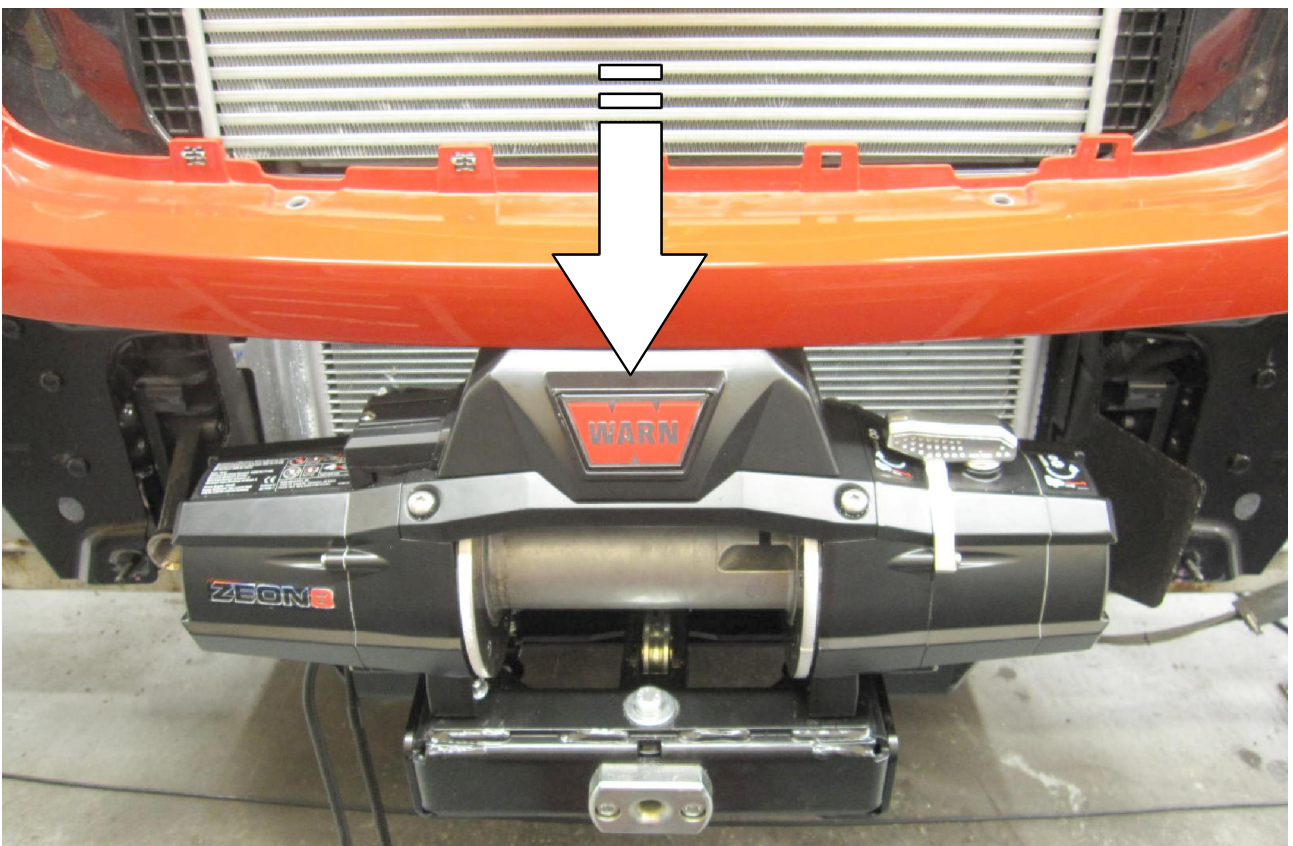

10

**Seilwinde befestigen! Vorne mit Original Schrauben (lang)  
hinten mit Senkkopfschrauben M10 x 40**  
*Install the winch! In front with original screws (long) and rear with  
countersunk screws M10 x 40!*



**11** **Seil einführen und Seilwinde anschließen!**  
*Insert the rope and connect the winch!*

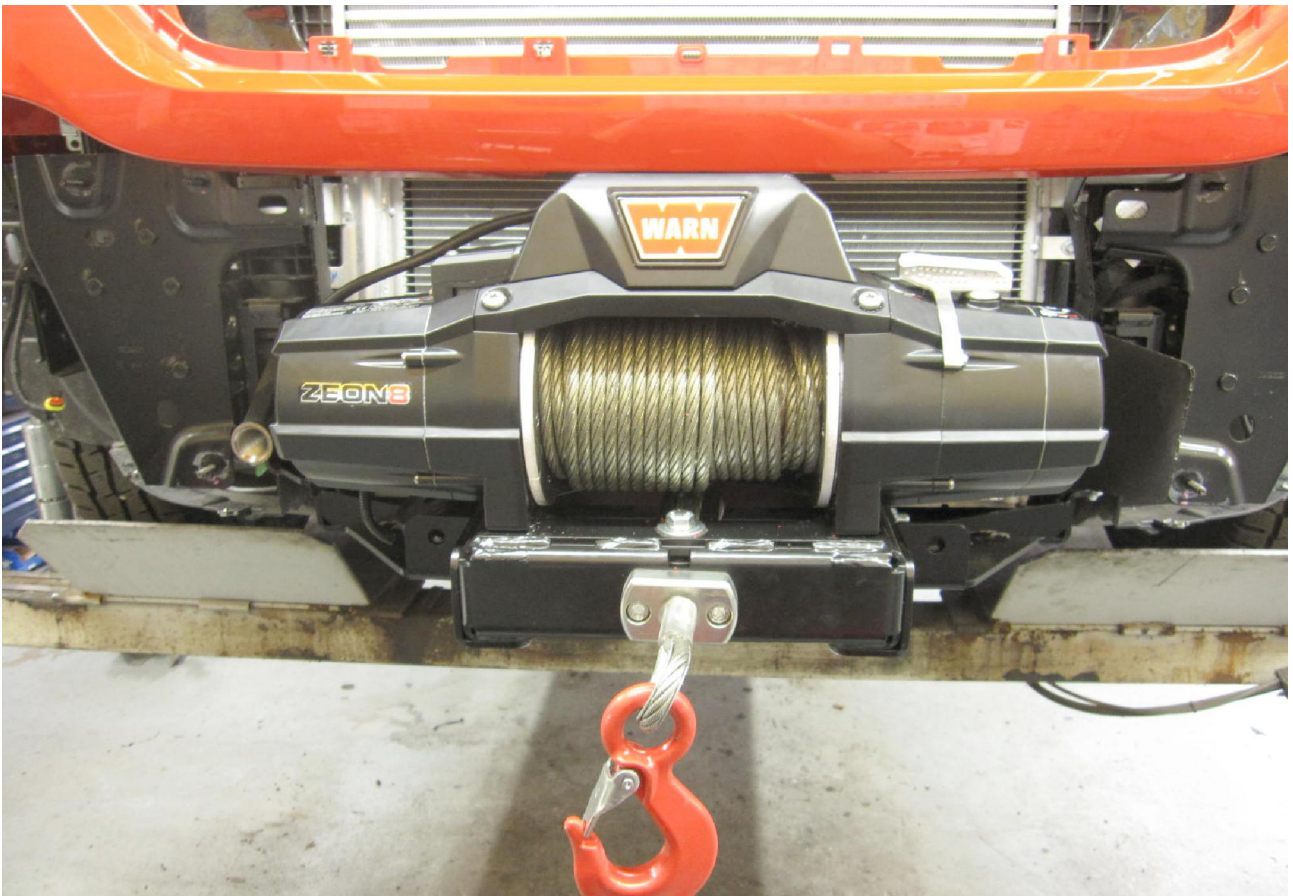

**12** **Seil aufspulen! / Spool the rope on!**



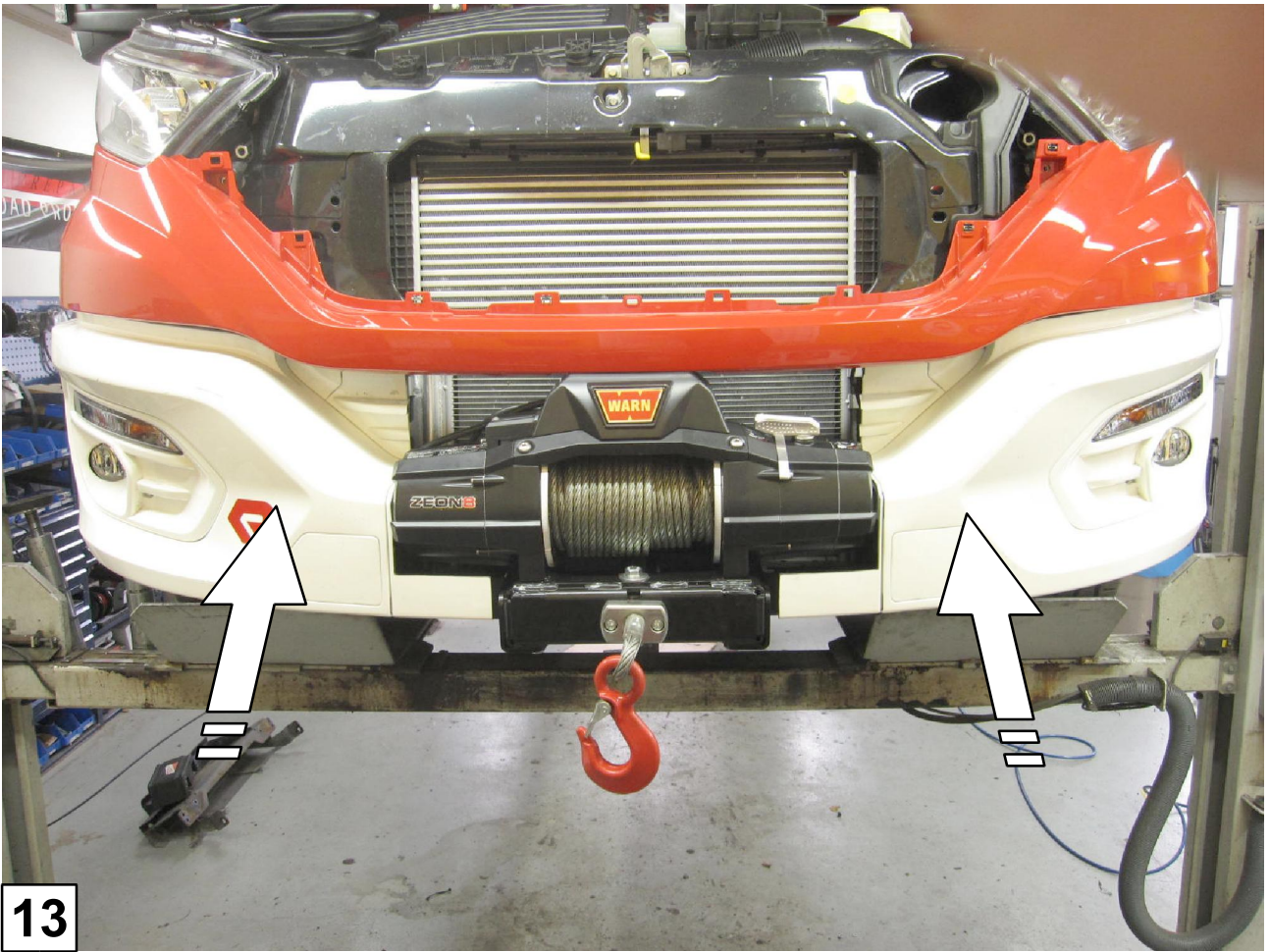

13

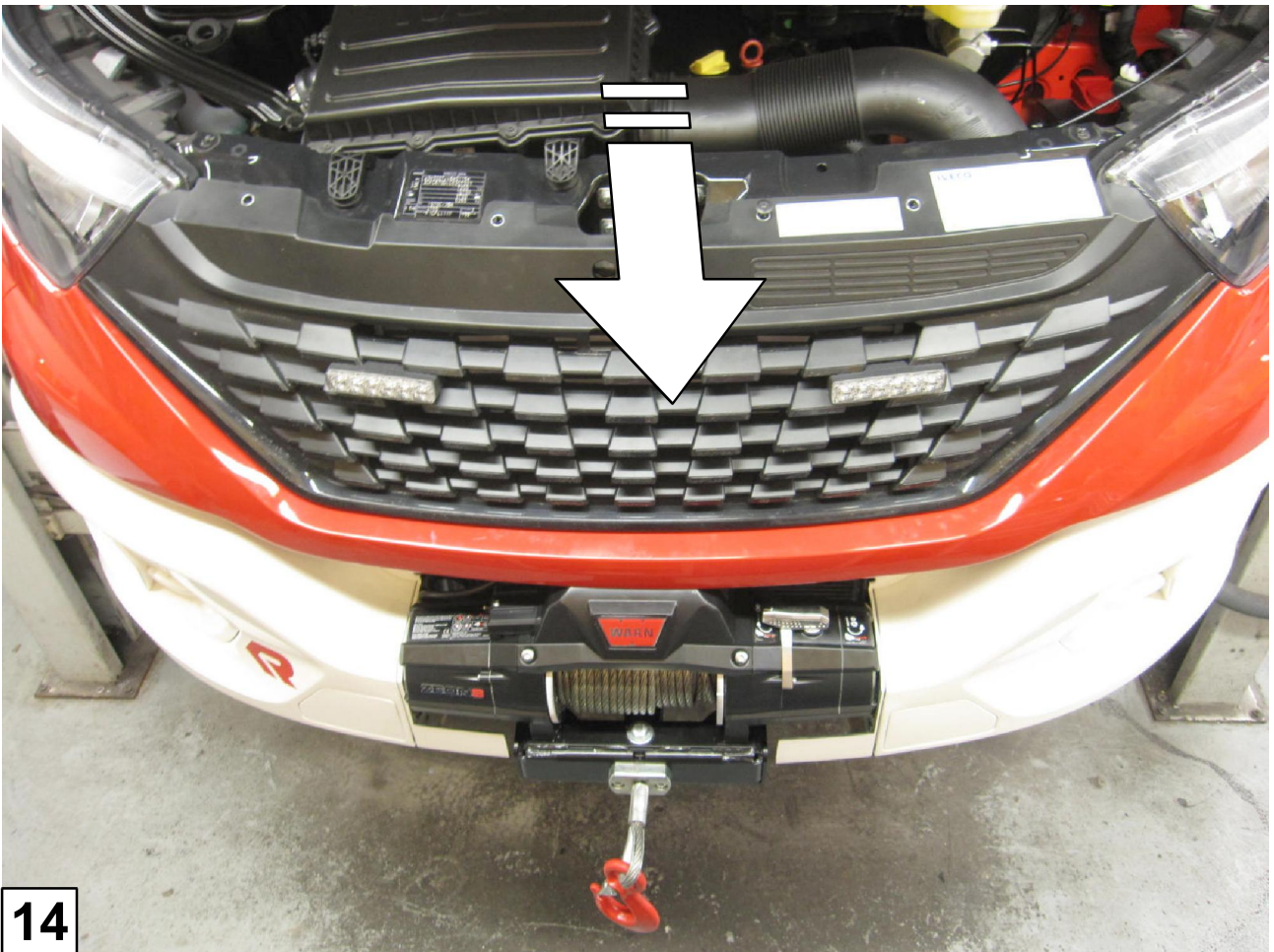

14

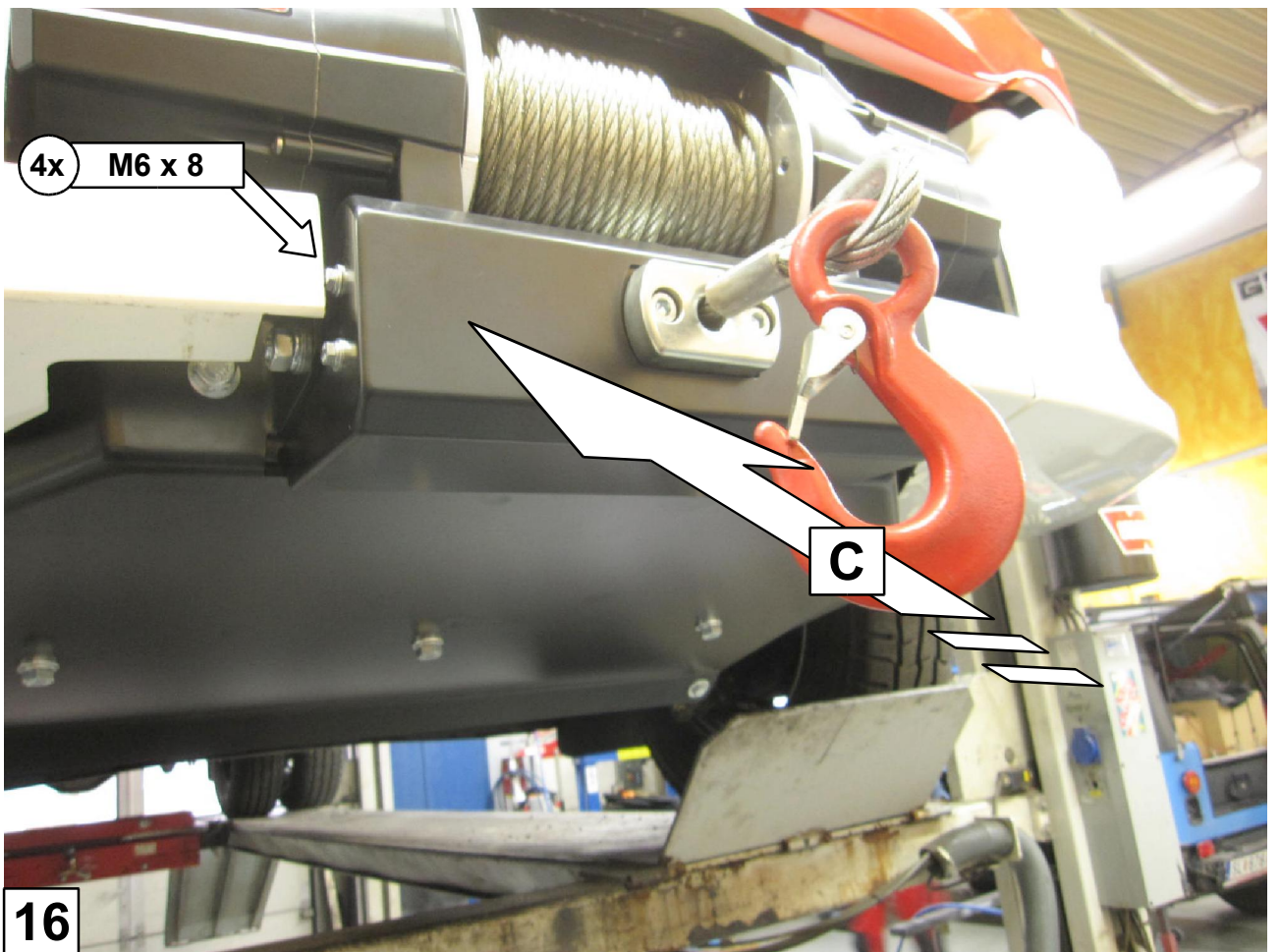
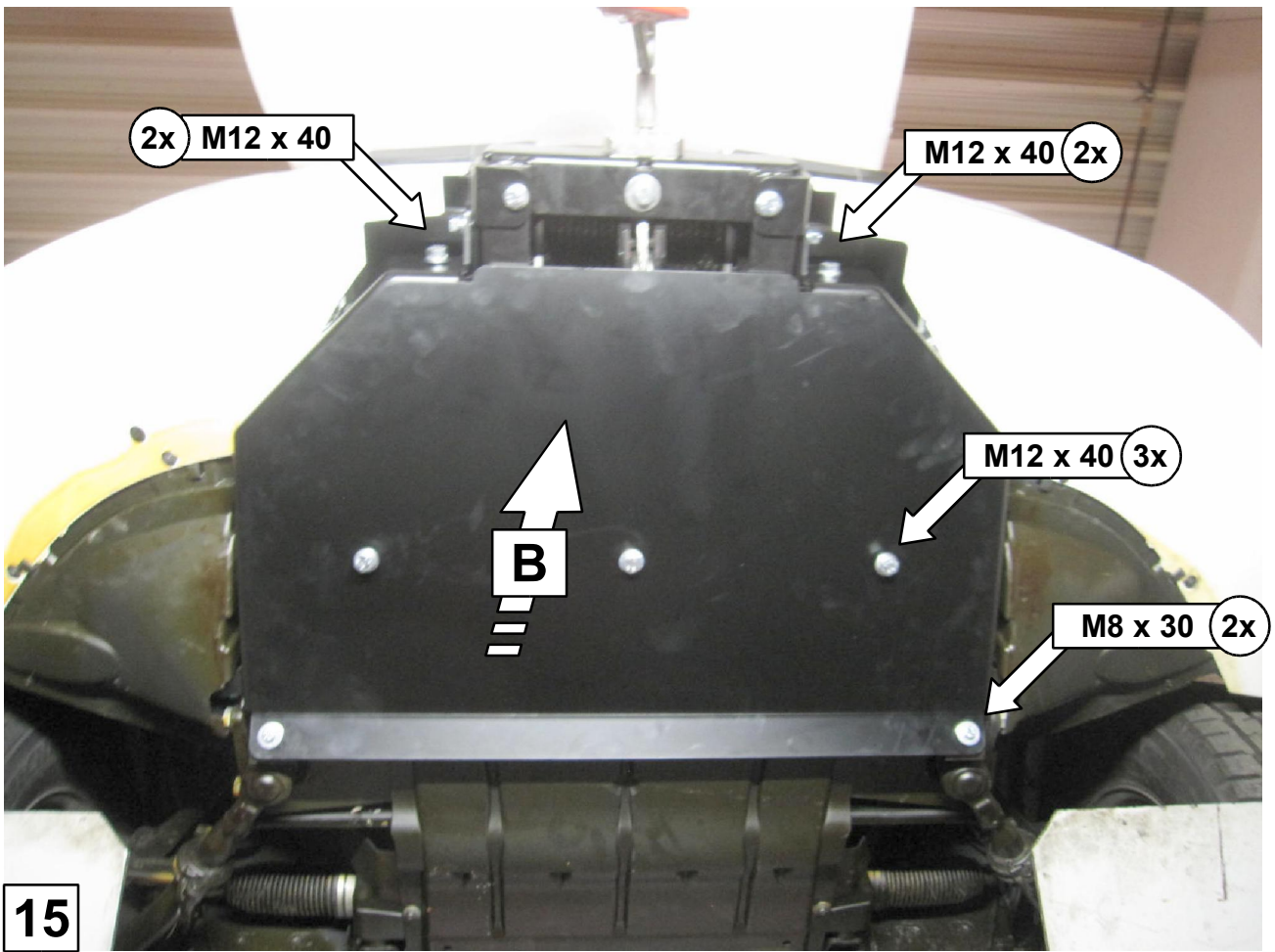



<b>Schrauben Anzugsmomente</b>	
<b>Schraubengröße</b>	<b>Güteklasse - 8.8</b>
M6	10 Nm
M8	25 Nm
M10	50 Nm
M12	87 Nm
M14	138 Nm
M16	210 Nm